

**1**

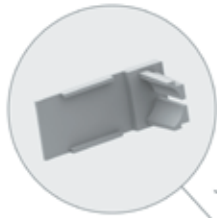

3mm.

3mm.

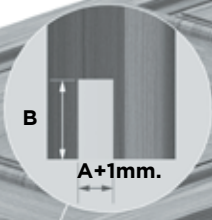
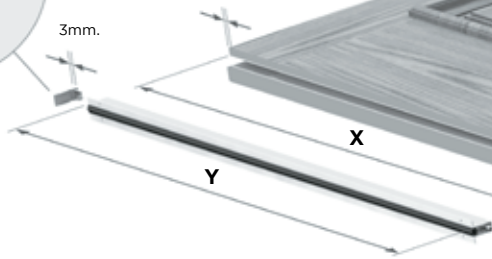

B

A+1mm.

**2**

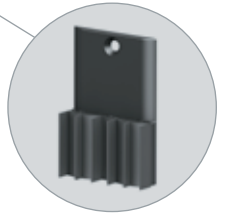

**3**



**3**

**3**

**4**

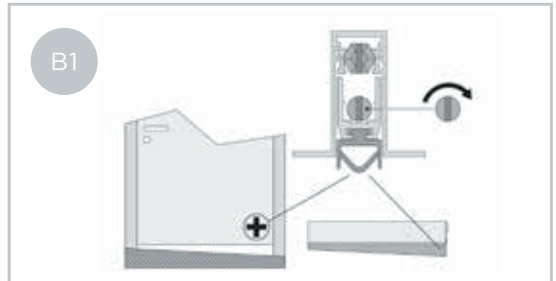
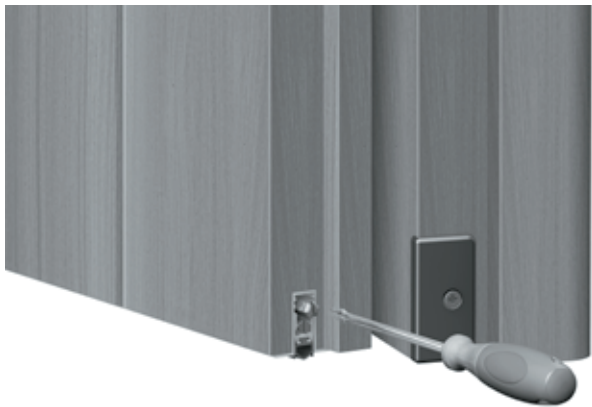

B1

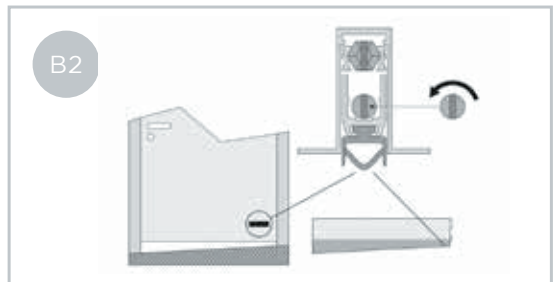

B2

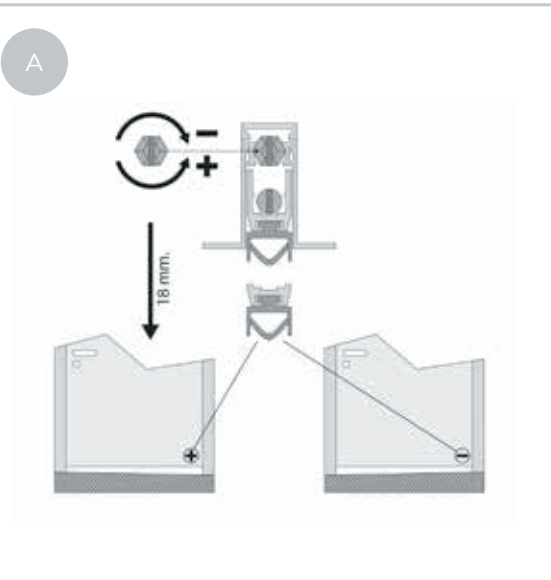

A

18 mm.